

Electric Dynafile® II

Safety, Operation and Maintenance – Save This Document and Educate All Personnel

Model	Offering	RPM	Abrasive Range
40610	Standard	11,000	1/4-3/4" x 18-34"
40611	Versatility Kit		



Find The Most Current Offering of Support Documents and Accessories at www.Dynabrade.com

⚠ WARNING

Read and understand this tool manual before operating your tool. Follow all safety rules for the protection of operating personnel as well as adjacent areas. For safety information, refer to Code of Federal Regulation – CFR 29 Part 1910, – Safety Requirements and applicable State and Local Regulations.

	Read and understand tool manual before work starts to reduce risk of injury to operator, visitors, and tool.	Practice safety requirements. Work alert, have proper attire, and do not operate tools under the influence of alcohol or drugs.	
	Eye protection must be worn at all times, eye protection to conform to ANSI Z87.1.	Ear protection to be worn when exposure to sound, exceeds the limits of applicable Federal, State or local statutes, ordinances and/or regulations.	
	Respiratory protection to be used when exposed to contaminants that exceed the applicable threshold limit values required by law.	Electric shock hazard. Avoid bodily contact with grounded objects, bodies of water. Do not damage cord set.	

Some dust created by sanding, grinding, drilling, and other construction activities contain chemicals known to cause cancer, birth defects or other reproductive harm. Some examples of these chemicals are:

- Lead from lead-based paints
- Crystalline silica from bricks and cement and other masonry products
- Arsenic and chromium from chemically treated lumber

Your risk from these exposures varies, depending on how often you do this type of work. To reduce your exposure to these chemicals: work in a well ventilated area, and work with approved safety equipment, such as those dust masks that are specially designed to filter out microscopic particles.

Caution: Hand, wrist and arm injury may result from repetitive work, motion and overexposure to vibration.

Tool Intent: Dynabrade Electric Dynafile® II used to sand, debur, blend and polish; metal, wood, stone, fiberglass or plastic surfaces.

GENERAL POWER TOOL SAFETY WARNINGS

⚠ WARNING Read all safety warnings and all instructions. Failure to follow the warnings and instructions may result in electric shock, fire and/or serious injury.

SAVE ALL WARNINGS AND INSTRUCTIONS FOR FUTURE REFERENCE

The term "power tool" in the warnings refers to your mains-operated (corded) power tool or battery-operated (cordless) power tool.

Work Area safety

1. Keep your work area clean and well lit. Cluttered or dark areas invite accidents.
2. Do not operate power tools in explosive atmospheres, such as in the presence of flammable liquids, gases, or dust. Power tools create sparks which ignite the dust or fumes.
3. Keep children and bystanders away while operating a power tool. Distractions can cause you to lose control.

Electrical Safety

1. Power tool plugs must match the outlet. Never modify the plug in any way. Do not use any adapter plugs with earthed (grounded) power tools. Unmodified plugs and matching outlets will reduce risk of electric shock.
2. Avoid body contact with earthed or grounded surfaces such as pipes, radiators, ranges and refrigerators. There is an increased risk of electric shock if your body is earthed or grounded.
3. Do not expose power tools to rain or wet conditions. Water entering a power tool will increase the risk of electric shock.
4. Do not abuse the cord. Never use the cord for carrying, pulling or unplugging the power tool. Keep cord away from heat, oil, sharp edges or moving parts. Damaged or entangled cords increase the risk of electric shock.

(continued on next page)

Electrical Safety (Continued)

5. When operating a power tool outdoors, use an extension cord suitable for outdoor use. *Use of a cord suitable for outdoor use reduces the risk of electric shock.*
6. If operating a power tool in a damp location is unavoidable, use a residual current device (RCD) protected supply. *Use of an RCD reduces the risk of electric shock.*

Personal Safety

1. Stay alert, watch what you are doing and use common sense when operating a power tool. Do not use power tool while you are tired or under the influence of drugs, alcohol, or medication. *A moment of inattention while operating power tools may result in serious personal injury.*
2. Use personal protective equipment. Always wear eye protection. *Protective equipment such as dust masks, non-skid safety shoes, hard hat, or hearing protection used for appropriate conditions will reduce personal injury.*
3. Prevent unintentional starting. Ensure the switch is in the off-position before connecting to power source and/or battery pack, picking up or carrying the tool. *Carrying power tools with your finger on the switch or energizing power tools that have the switch on invites accidents.*
4. Remove any adjusting key or wrench before turning the power tool on. *A wrench or a key left attached to a rotating part of the power tool may result in personal injury.*
5. Do not overreach. Keep proper footing and balance at all times. *This enables better control of the power tool in unexpected situations.*
6. Dress properly. Do not wear loose clothing or jewelry. Keep your hair, clothing and gloves away from moving parts. *Loose clothes, jewelry or long hair can be caught in moving parts.*
7. If devices are provided for the connection of dust extraction and collection facilities, ensure these are connected and properly used. *Use of dust collection can reduce dust-related hazards.*

Power Tool Use and Care

1. Do not force the power tool. Use the correct power tool for your application. *The correct tool will do the job better and safer at the rate for which it was designed.*
2. Do not use the power tool if switch does not turn it on and off. *Any power tool that cannot be controlled with the switch is dangerous and must be repaired.*
3. Disconnect the plug from the power source and/or the battery pack from the power tool before making any adjustments, changing accessories, or storing power tool. *Such preventative safety measures reduce the risk of starting the power tool accidentally.*
4. Store idle power tools out of the reach of children and do not allow persons unfamiliar with the power tool or these instructions to operate the power tool. *Power tools are dangerous in the hands of untrained users.*
5. Maintain power tools. Check for misalignment or binding of moving parts, breakage of parts and any other condition that may affect the power tool's operation. If damaged, have the power tool repaired before use. *Many accidents are caused by poorly maintained power tools.*
6. Keep cutting tools sharp and clean. *Properly maintained cutting tools with sharp cutting edges are less likely to bind and are easier to control.*
7. Use the power tool, accessories and tool bits etc. in accordance with these instructions, taking into account the working conditions and the work to be performed. *Use of the power tool for operations different from those intended could result in a hazardous situation.*

Service

1. Have your power tool serviced by a qualified repair person using only identical replacement parts. This will ensure that the safety of the power tool is maintained.

SPECIFIC SAFETY RULES

1. Hold power tool by insulated gripping surfaces, because the belt may contact its own cord. Cutting a "live" wire may make exposed metal parts of the power tool "live" and could give the operator an electric shock.
2. Use a vise or clamping device to restrain work piece.

(See Definitions for label symbols on pg. 3)

TOOL DESCRIPTION

Dynaflex II – is a electric hand tool with a moving narrow belt. Tool is equipped as shown on page 3.

ASSEMBLY and OPERATION INSTRUCTIONS

1. With power source disconnected from tool rotate head to desired position and tighten set screw with hex wrench provided to clamp.
2. Connect power source to tool. Be careful not to depress switch in the process.
3. Hold tool by the motor housing only. One or two hands may be used. Do Not hold tool by head/housing assembly. Keep hands away from all grinding/sanding edges and moving parts. A side handle is included for two hand operation of tool.
4. Depress switch to start tool. Switch can be locked with button on side of handle, depress switch to release.
5. Adjust belt tracking by turning 95218 Adjustment Knob to the left or right accordingly, so as abrasive belt rides evenly over contact arm.
6. Working off the return path of the abrasive belt will ensure superior tracking.

MAINTENANCE and ACCESSORY CARE INSTRUCTIONS

Important: A preventative maintenance program is recommended whenever portable power tools are used.

- Use only genuine Dynabrade replacement parts to insure quality. To order replacement parts, specify **Model #**, **Serial #** and **RPM** of your tool.

Routine Preventative Maintenance:

- Mineral spirits are recommended when cleaning the sanding heads. Do not use on electrical components or clean tool or parts with any solvents or oils containing acids, esters, ketones, chlorinated hydrocarbons or nitro carbons. Compressed air may be used to remove dirt from electrical components.
- **DO NOT** clean or maintain tools with chemicals that have a low flash point (example: VWD-40®).
- Tool labels must be kept legible at all times, if not, reorder label(s) and replace. User is responsible for maintaining specification information i.e.: Model #, S/N, and RPM. (See Assembly Breakdown)
- Visually inspect plugs and cords for frays, visible damage and signs of deterioration. Damaged or worn components must be replaced by Dynabrade to avoid a safety hazard.
- Brush Changing – Unplug tool, remove rear housing and brushes. Install new brushes, and replace rear housing. Run tool for 20 minutes at free speed to seat brushes. Change brushes every 100 hrs. to ensure proper tool function. After changing brushes it is recommended to replace the right angle gear grease with 95542 Grease.
- **After maintenance is performed on tool check for excessive tool vibration.**
- **Check for excessive current leakage at 550 volts with a current leakage checker on all screws and the gear case, if the electrical components have been disturbed during repair.**

Handling and Storage of Tool and Accessories:

- Use of tool rests, hangers and/or balancers is recommended.
- **DO NOT** carry tool by cord.
- Protect abrasive accessories from exposure to water, solvents, high humidity, freezing temperature and extreme temperature changes.
- Store accessories in protective racks or compartments to prevent damage.

Model 40610 Complete Assembly

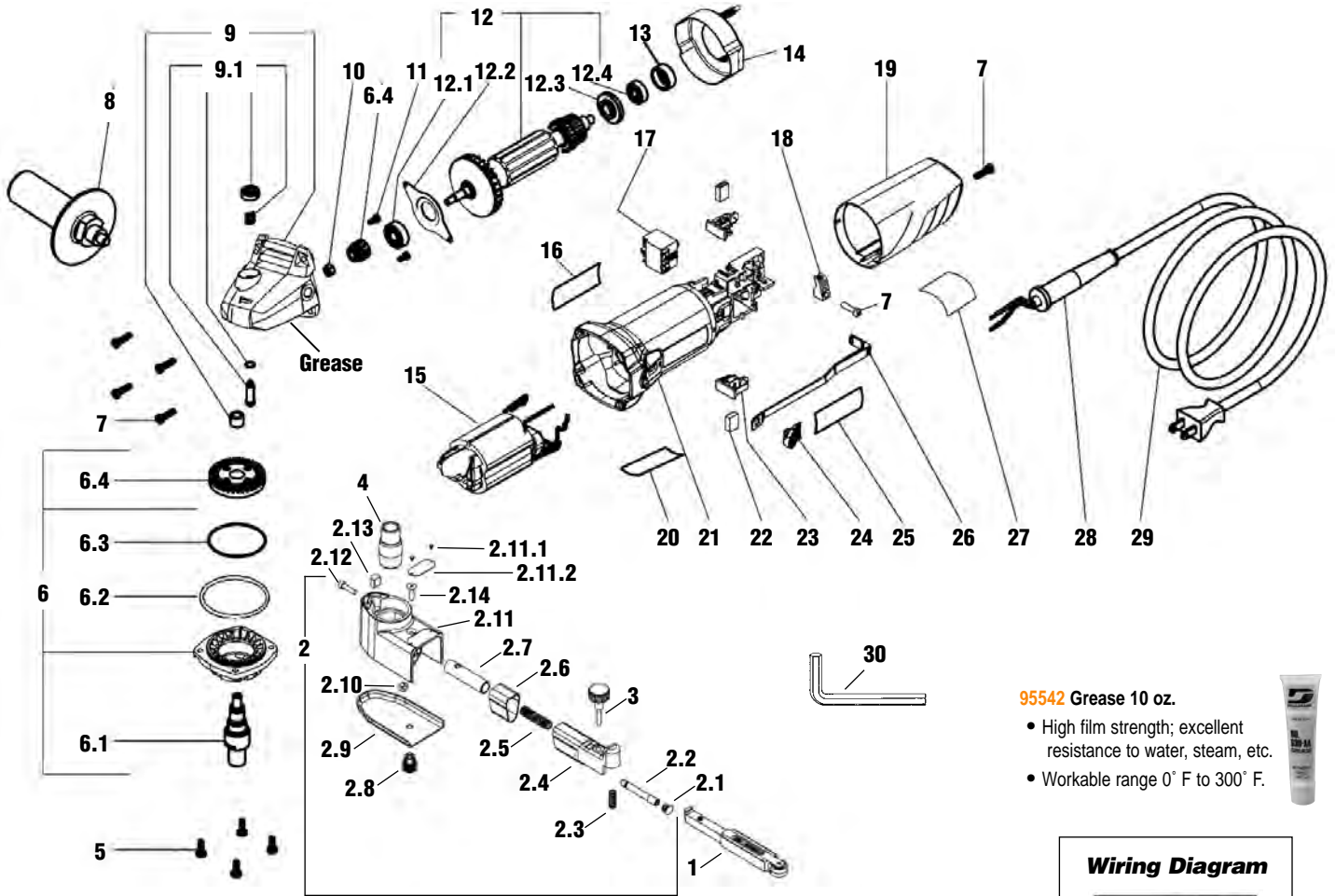

95542 Grease 10 oz.

- High film strength; excellent resistance to water, steam, etc.
- Workable range 0° F to 300° F.



Wiring Diagram

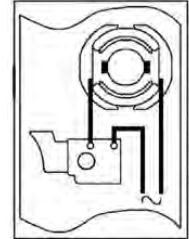

Index Key

No.	Part #	Description
1	11203	Contact Arm Assembly
2	40759	Belt Housing Assembly
2.1	96334	Plug
2.2	15308	Guide Post
2.3	11040	Spring
2.4	15306	Tension Arm
2.5	95426	Spring
2.6	15309	Shield
2.7	15307	Tension Shaft
2.8	15329	Captive Screw
2.9	15312	Housing Cover (Includes 15329)
2.10	96335	Hex Nut
2.11	40760	Belt Housing (Includes 40761, 95442)
2.11.1	95442	Screw
2.11.2	40761	Label - Belt Housing
2.12	95311	Screw
2.13	40029	Cam Lock
2.14	95217	Screw
3	95218	Knob
4	15336	Drive Wheel
5	40724	Screw (4)
6	40762	Spindle Assembly
6.1	40763	Spindle
6.2	40728	Washer
6.3	40729	O-Ring
6.4	40730	Pinion/Gear Set
7	40731	Screw (6)
8	40258	Side Handle
9	40733	Gear Housing Assy.
9.1	40734	Spindle Lock Assy.
10	40735	Nut
11	40736	Screw (2)
12	40737	Armature Assembly
12.1	02649	Bearing
12.2	40738	Bearing Retainer
12.3	40739	Bearing Shield
12.4	01015	Bearing
13	40740	Bearing Seat
14	40741	Fan Baffle
15	40742	Field Coil Assembly
16	40764	Label - Specification
17	40744	Switch
18	40746	Cord Clamp
19	40747	Rear Cover
20	40748	Label - Safety
21	40749	Motor Housing
22	40750	Carbon Brush Set
23	40751	Brush Holder
24	40752	Switch Button
25	40753	Label - Logo
26	40754	Switch Rod
27	40755	Label - Maintenance
28	40756	Cord Sleeve
29	40757	Cord Set
30	95134	Hex Wrench (9/64")

Definitions of Label Symbols

Symbol	Description
Aamperes
Hzhertz
□Class II Construction
RPMrevolutions per minute
vvolts
wwatts

Model Number	Motor RPM	Watts	Abrasive Belt Size Inch (mm)	Voltage	Current	Phase	Frequency	Max. SFPM (SMPM)	Weight Pound (kg)	Length Inch (mm)	Height Inch (mm)
All Models	11,000	680	1/4-3/4 (6-19) W x 18-24 (457-610) L	120 V (AC)	6 amp.	1	60 Hz	2,520 (768)	5 (2.3)	19 (483)	5.5 (140)

One Year Warranty

Following the reasonable assumption that any inherent defect which might prevail in a product will become apparent to the user within one year from the date of purchase, all equipment of our manufacture is warranted against defects in workmanship and materials under normal use and service. We shall repair or replace at our factory, any equipment or part thereof which shall, within one year after delivery to the original purchaser, indicate upon our examination to have been defective. Our obligation is contingent upon proper use of Dynabrade tools in accordance with factory recommendations, instructions and safety practices. It shall not apply to equipment which has been subject to misuse, negligence, accident or tampering in any way so as to affect its normal performance. Normally wearable parts such as bearings, brushes, gears, etc., are not covered under this warranty.

Electric Dynabrade® II Contact Arms

Arms for 4" to 12" workable reach.



Optional **40078 Adapter** allows use of 24" long belts; extends reach to 7" when used with contact arm.

11200

Work on broad areas, leaves in-line scratch, blend stainless.

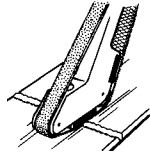
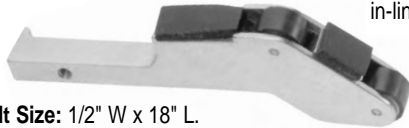

Belt Size: 1/2" W x 18" L.
Contact Wheel: 5/8" dia. x 3/8" W, rubber.
Platen: 1/2" wide.

11201

45 PSI maximum. Enter channels as small as 7/16".

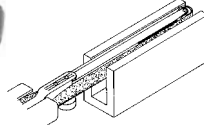
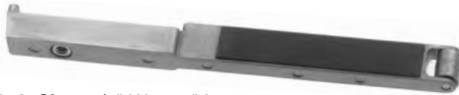

Belt Size: 1/2" W x 18" L.
Contact Wheel: 5/16" dia. x 3/8" W, steel.
Platen: 1/2" wide.

11203* Order 11312 for heavy-duty version.

Grind over contact wheel or platen.

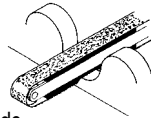

Belt Size: 1/2" W x 18" L.
Contact Wheel: 5/8" dia. x 3/8" W, rubber. **Platen:** 1/2" wide.

11204 – "Unique Offset Design"

Strap polish is easy with this arm!

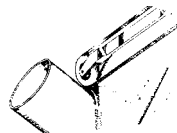

Belt Size: 1/4" or 1/2" W x 18" L.
Contact Wheel: 1" dia. x 3/8" W, rubber. **Platen:** None due to offset design.

11206* Order 11326 for Heavy Duty/Steel Construction version.

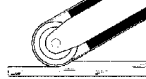

Belt Size: 5/8" or 3/4" W x 18" L.
Contact Wheel: 3/4" dia. x 5/8" wide, rubber. **Platen:** 3/4" wide.

11280

Strap polish here tapered

Grind corners, enter grooves, strap polish.

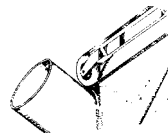

Belt Size: 1/4" W x 18" L.
Contact Wheel: 1" dia. x 3/8" wide, urethane, tapered.
Platen: No platen due to offset design.

11286

11024 steel platen available. 6-3/4" workable reach.



Belt Size: 1/2" W x 24" L.
Contact Wheel: 5/8" dia. x 3/8" W, rubber. **Platen:** 1/2" wide.

11287* Uses 20-1/2" Belts

Grind on contact wheel or platen; has 5-1/4" workable reach.

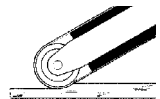

Belt Size: 5/8" or 3/4" W x 20-1/2" L
Contact Wheel: 3/4" dia. x 5/8" W, rubber. **Platen:** 3/4" wide.

11304 "The Banana Arm"

Work on broad areas; leaves in-line scratch; blend stainless.

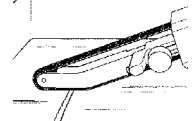

Belt Size: 1/2" W x 18" L.
Contact Wheel: 5/8" dia. x 3/8" wide, rubber. **Platen:** 1/2" wide.

11322 Guide-Cut

Removes raised material within .020" or less without undercutting.



Guide Wheels Prevent Undercutting

Belt Size: 1/2" W x 18" L. 60 to 80 grit.
Contact Wheel: 5/8" dia. x 3/8" W, rubber.

11350* "Bus Bar"

Excellent for cleaning oxide off electrical bus bars. Arm has a 12" workable reach.



Belt Size: 3/4" W x 34" L.
Contact Wheel: 5/16" dia. x 5/8" W, steel. **Platen:** 3/4" wide, optional.

11220*, 11300*, 11301*, 11341*

Polish Turbine Blades

Offset design and miniature contact wheels. 2" strap polish in offset area; polish turbine blades and other contours.

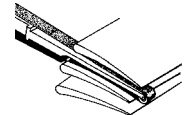

Belt Sizes: 11220 uses 5/8" or 3/4" W x 18" L. All others use 1/2" W x 18" L.

Contact wheels description for each above arm:

11220: 5/16" dia. x 5/8" W, steel. 11300: 1/4" dia. x 3/8" W, steel.
11301: 5/16" dia. x 3/8" W, steel. 11341: 5/16" dia. x 3/8" W, rubber.

Reference Contact Information

American National Standards Institute (ANSI)
1899 L Street, NW, 11th Floor • Washington, DC 20036 • Tel: 1 (202) 293-8020

Compressed Air & Gas Institute
1300 Sumner Ave. • Cleveland, OH 44115-2851
Tel: 1 (216) 241-7333 • Fax: (216) 241-0105

European Committee for Standardization
Rue de Stassart 36 • B - 1050 Brussels, Belgium

International Organization of Standards
Case postale 56 • CH-1211 Geneva 20
Tel: + 41 22 749 01 11 • Fax: + 41 22 749 09 47

Government Printing Office
Superintendent of Documents • Attn: New Orders
P.O. Box 371954 • Pittsburgh, PA 15250-7954
Tel: 1 (202) 512-1803

