

Electric Dynafile® II

Tool Manual – Safety, Operation and Maintenance

SAVE THIS DOCUMENT, EDUCATE ALL PERSONNEL

Models:

40500 – 120 V / 60 Hz

40501 – Versatility Kit



⚠ WARNING

Read and understand this tool manual before operating your tool. Follow all safety rules for the protection of operating personnel as well as adjacent areas. For safety information, refer to Safety Requirements for the Use, Care and Protection of Abrasive Wheels – ANSI B7.1, Code of Federal Regulation – CFR 29 Part 1910, European Committee for Standards (EN) Hand Held Electric Motor Operated Tools – Safety Requirements and applicable State and Local Regulations.

SAFETY LEGEND

	⚠ WARNING Read and understand tool manual before work starts to reduce risk of injury to operator, visitors, and tool.	⚠ WARNING Practice safety requirements. Work alert, have proper attire, and do not operate tools under the influence of alcohol or drugs.	
	⚠ WARNING Eye protection must be worn at all times, eye protection to conform to ANSI Z87.1.	⚠ WARNING Ear protection to be worn when exposure to sound, exceeds the limits of applicable Federal, State or local statutes, ordinances and/or regulations.	
	⚠ WARNING Respiratory protection to be used when exposed to contaminants that exceed the applicable threshold limit values required by law.	⚠ WARNING Electric shock hazard. Avoid bodily contact with grounded objects, bodies of water. Do not damage cord set.	

GENERAL SAFETY RULES

WARNING! Read and understand all instructions. Failure to follow all instructions listed below, may result in electric shock, fire and/or serious personal injury.

SAVE THESE INSTRUCTIONS

Work Area

1. Keep your work area clean and well lit. Cluttered benches and dark areas invite accidents.
2. Do not operate power tools in explosive atmospheres, such as in the presence of flammable liquids, gases, or dust. Power tools create sparks which ignite the dust or fumes.
3. Keep bystanders, children, and visitors away while operating a power tool. Distractions can cause you to lose control.

Electrical Safety

1. Double Insulated tools are equipped with a polarized plug (one blade is wider than the other). This plug will fit in polarized outlet only one way. If the plug does not fit fully in the outlet, reverse the plug. If it still does not fit, contact a qualified electrician to install a polarized outlet. Do not change the plug in any way. Double Insulation eliminates the need for the three wire grounded power cord and grounded power supply system.
2. Avoid body contact with grounded surfaces such as pipes, radiators, ranges and refrigerators. There is an increased risk of electric shock if your body is grounded.
3. Don't expose power tools to rain or wet conditions. Water entering a power tool will increase the risk of electric shock.
4. Do not abuse the cord. Never use the cord to carry the tools or pull the plug from an outlet. Keep cord away from heat, oil, sharp edges or moving parts. Replace damaged cords immediately. Damaged cords increase the risk of electric shock.

(continued on next page)

5. When operating a power tool outside, use an outdoor extension cord marked "W-A" or "W." These cords are rated for outdoor use and reduce the risk of electric shock.

Personal Safety

1. Stay alert, watch what you are doing and use common sense when operating a power tool. Do not use tool while tired or under the influence of drugs, alcohol, or medication. A moment of inattention while operating power tools may result in serious personal injury.
2. Dress properly. Do not wear loose clothing or jewelry. Contain long hair. Keep your hair, clothing, and gloves away from moving parts. Loose clothes, jewelry, or long hair can be caught in moving parts.
3. Avoid accidental starting. Be sure switch is off before plugging in. Carrying tools with your finger on the switch or plugging in tools that have the switch on invites accidents.
4. Remove adjusting keys or switches before turning the tool on. A wrench or a key that is left attached to a rotating part of the tool may result in personal injury.
5. Do not overreach. Keep proper footing and balance at all times. Proper footing and balance enables better control of the tool in unexpected situations.
6. Use safety equipment. Always wear eye protection. Dust mask, non-skid safety shoes, hard hat, or hearing protection must be used for appropriate conditions.

Tool Use and Care

1. Use clamps or other practical way to secure and support the workpiece to a stable platform. Holding the work by hand or against your body is unstable and may lead to loss of control.
2. Do not force tool. Use the correct tool for your application. The correct tool will do the job better and safer at the rate for which it is designed.
3. Do not use tool if switch does not turn it on or off. Any tool that cannot be controlled with the switch is dangerous and must be repaired.
4. Disconnect the plug from the power source before making any adjustments, changing accessories, or storing the tool. Such preventative safety measures reduce the risk of starting the tool accidentally.
5. Store idle tools out of reach of children and other untrained persons. Tools are dangerous in the hands of untrained users.
6. Maintain tools with care. Keep cutting tools sharp and clean. Properly maintained tools, with sharp cutting edges are less likely to bind and are easier to control.
7. Check for misalignment or binding of moving parts, breakage of parts, and any other condition that may affect the tools operation. If damaged, have the tool serviced before using. Many accidents are caused by poorly maintained tools.
8. Use only accessories that are recommended by the manufacturer for your model. Accessories that may be suitable for one tool, may become hazardous when used on another tool.

Service

1. Tool service must be performed only by qualified repair personnel. Service or maintenance performed by unqualified personnel could result in a risk of injury.
2. When servicing a tool, use only identical replacement parts. Follow instructions in the Maintenance section of this manual. Use of unauthorized parts or failure to follow Maintenance Instructions may create a risk of electric shock or injury.

SPECIFIC SAFETY RULES

1. Hold tool by insulated gripping surfaces when performing an operation where the cutting tool may contact hidden wiring or its own cord. Contact with a "live" wire will make exposed metal parts of the tool "live" and shock the operator.

(See Definitions for label symbols on pg. 4)

TOOL DESCRIPTION

Dynaflex II – Is an electric hand tool with a moving sanding belt, tool includes: an on/off switch, side handle, Dynaflex II Belt Sanding Head Assembly, and is equipped with a 8 ft. cord set.

ASSEMBLY and OPERATION INSTRUCTIONS

1. With power source disconnected from tool rotate head to desired position and tighten set screw with hex wrench provided to clamp.
2. Connect power source to tool. Be careful not to depress switch in the process.
3. Hold tool by the motor housing only. One or two hands may be used. Do Not hold tool by head/housing assembly. Keep hands away from all grinding/sanding edges and moving parts. A side handle is included for two hand operation of tool. (See "Installing Side Handle" Instructions.)
4. Slide and rock slide switch forward to start tool. Touch rear of slide switch to release.
5. While tool is running, adjust belt tracking by turning 95218 Rough Adjustment Knob to the left or right accordingly, so as abrasive belt rides evenly over contact arm.
6. Always work off the return side of the abrasive belt. This will ensure superior tracking and reduce downtime of tool.

MAINTENANCE and ACCESSORY CARE INSTRUCTIONS

Important: A preventative maintenance program is recommended whenever portable power tools are used.

- Use only genuine Dynabrade replacement parts to insure quality. To order replacement parts, specify **Model #**, **Serial #** and **SFPM** of your tool.

Routine Preventative Maintenance:

- Mineral spirits are recommended when cleaning the Dynaflex II Assembly. Do not use on electrical components or clean tool or parts with any solvents or oils containing acids, esters, ketones, chlorinated hydrocarbons or nitro carbons. Blow the dirt from electrical components with air.
- **DO NOT** clean or maintain tools with chemicals that have a low flash point (example: WD-40®).
- Tool labels must be kept legible at all times, if not, send tool in for relabeling. User is responsible for maintaining specification information i.e.: Model #, S/N, and SFPM. (See Assembly Breakdown)
- Visually inspect plugs and cords for frays, visible damage and signs of deterioration. Replace damaged or worn components.
- Refer to Dynabrade's Warning/Safety Operating Instructions Tag (Reorder No. 95903) for safety information.
- Brush Changing – When the brushes wear down to a predetermined length, the tool is automatically shut off to prevent damage to the armature. Unplug tool and remove brush caps (item #23) and replace brushes (item #22). Replace brush caps.

After maintenance is performed on tool check for excessive tool vibration. Check for excessive current leakage at 550 volts with a current leakage tester on all screws and the gear case, if the electrical components have been disturbed during repair.

Handling and Storage of Tool and Accessories:

- Use of tool rests, hangers and/or balancers is recommended.
- **DO NOT** carry tool by cord.

Important Operating and Safety Instructions

Carefully read all instructions before operating or servicing any Dynabrade® Abrasive Power Tool.

Warning: Hand, wrist and arm injury may result from repetitive work motion and overexposure to vibration.

Operating Instructions:

Warning: Eye, face, respiratory, sound and body protection must be worn while operating power tools. Failure to do so may result in serious injury or death. Follow safety procedures posted in workplace.

Abrasive Belt/Contact Arm Change Instructions

To Change Belt:

1. Disconnect power source.
2. Remove **15312** Belt Guard by unscrewing **15329** Screw.
3. Pull back on tension arm assembly.
4. Remove and replace abrasive belt and belt guard.
5. Connect power source.
6. Adjustment belt is tracking by turning **95218** Rough Adjustment Knob to the left or right accordingly while machine is running.

To Change Contact Arm Assembly:

1. Disconnect power source.
2. Remove **15312** Belt Guard by unscrewing **15329** Screw.
3. Pull back on tension arm assembly and remove abrasive belt.
4. Remove **95218** Rough Adjustment Knob.
5. Remove contact arm and replace with desired arm, making sure that the tab on the end of the arm is facing downward.
6. Replace **95218** Knob.
7. Install abrasive belt and replace belt guard.
8. Connect power source and adjust belt tracking by turning **95218** Knob.

Housing Angle Adjustment: To pivot housing, loosen **95311** Screw on housing with the supplied 9/64" hex wrench (P/N – **95134**). Pivot housing to desired angle and retighten **95311** Screw.

Installing Side Handle: The side handle may be installed on either side of the gear case for right or left hand operation. Position the side handle on the side offering the best comfort and control of the tool. To install, thread side handle into side handle socket on desired side of gear case and tighten securely.

Abrasive Types and Cloth Polishing Belts

Coated Aluminum Oxide

The most widely used abrasive grain. This tough durable synthetic is used for grinding and deburring high carbon steels, general metalworking and for sanding certain hardwoods.

Ceramic Coated Aluminum Oxide

Synthetic grain two-to-three times tougher than conventional aluminum oxide.

Coated Silicon Carbide

Excellent for sanding primer and sealer. This sharp, fast-penetrating grain is used for sanding soft materials such as plastics and fibrous wood.

Coated Alumina Zirconia

Effective for coarse stock removal of metal and wood. This synthetic grain has self-sharpening characteristics and provides continuous new cutting edges for longer life and greater efficiency.

Abrasive Impregnated Non-Woven Nylon

A non-woven synthetic fiber and an abrasive mineral are bonded together to form a tough, open web that is chemically resistant and long-lasting. This web design allows controlled conformable contact to workpiece contours, corners and edges. The product wears away slowly, exposing new abrasive leaving a uniform, consistent surface. It also conditions surfaces without removing or damaging the base material and is excellent for deburring, cleaning, blending and final finishing of metal, wood and plastics. It is available in many forms such as belts, discs and wheels. Various mineral grades are available ranging from very coarse to ultra-fine.

Cloth Polishing Belts

Used on power tools in conjunction with Dynuba® polishing compounds. The result is brilliant cut, color and luster on metals such as stainless steel, aluminum, copper and brass.

All abrasive accessories may be found in the most current Dynabrade® Catalog and abrasive literature.

One Year Warranty

Following the reasonable assumption that any inherent defect which might prevail in a product will become apparent to the user within one year from the date of purchase, all equipment of our manufacture is warranted against defects in workmanship and materials under normal use and service. We shall repair or replace at our factory, any equipment or part thereof which shall, within one year after delivery to the original purchaser, indicate upon our examination to have been defective. Our obligation is contingent upon proper use of Dynabrade tools in accordance with factory recommendations, instructions and safety practices. It shall not apply to equipment which has been subject to misuse, negligence, accident or tampering in any way so as to affect its normal performance. Normally wearable parts such as bearings, contact wheels, brushes, gears, etc., are not covered under this warranty.

Housing Assembly

Index Key	
No.	Part # Description
1	Contact Arm Assembly (See Chart on pg.6)
2	96334 Plug
3	15308 Guide Post
4	11040 Spring
5	15306 Tension Arm
6	95426 Spring
7	95218 Knob Assembly
8	15309 Dust Cover
9	15307 Tension Shaft
10	15329 Screw
11	15312 Belt Guard
12	96335 Hex Nut
13	15366 Housing
14	95311 Screw
15	40029 Motor Lock
16	95217 Screw
17	15316 Drive Wheel
18	40505 Motor Assembly

Definitions of Label Symbols	
Symbol	Description
Aamperes
Hzhertz
□Class II Construction
SFPMSurface Feet Per Min.

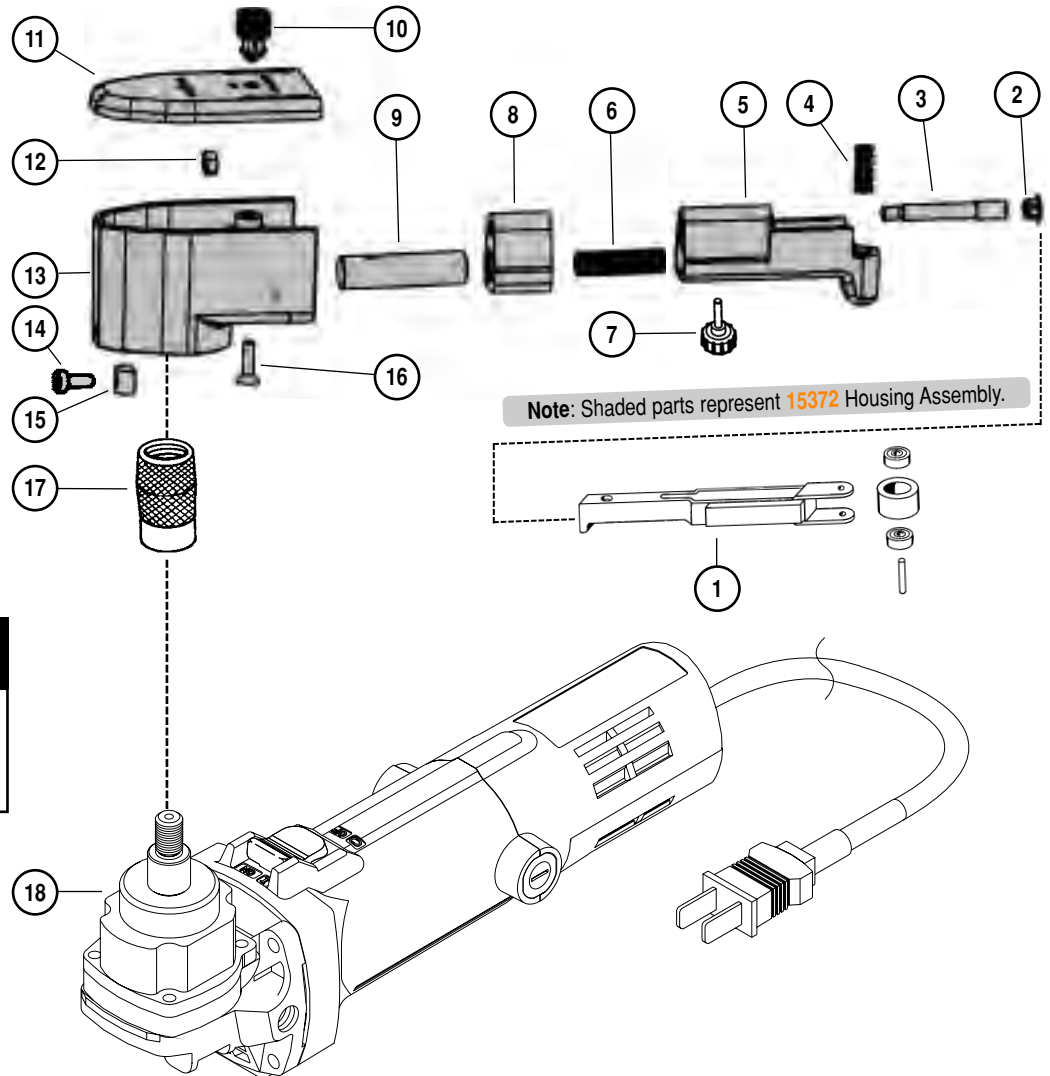

Extension Cords

Double insulated tools can use either a two or three wire extension cord. As the distance from the supply outlet increases, you must use a heavier gauge extension cord. Using extension cords with inadequately sized wire causes a serious drop in voltage resulting in loss of power and possible tool damage. Refer to the table below to determine the required minimum wire size.

Nameplate Ampere	Extension Cord Length					
	25'	50'	75'	100'	150'	200'
0-5.0	16	16	16	14	12	12
5.1-8.0	16	16	14	12	10	-
8.1-12.0	14	14	12	10	-	-
12.1-15.0	12	12	10	10	-	-
15.1-20.0	10	10	10	-	-	-

**Based on limiting the line voltage drop to live volts at 150% of the rated ampere.*

The smaller the gauge number of the wire the greater the capacity of the cord. For example a 14 gauge cord can carry a higher current than a 16 gauge cord. When using more than one extension cord to make up the total length, be sure each cord contains at least the minimum wire size required. If you are using one extension cord for more than one tool, add the nameplate ampere and use the sum to determine the required minimum wire size.

Guidelines For Using Extension Cords

- If you are using an extension cord outdoors, be sure it is marked with the suffix "W-A" ("W" in Canada) to indicate that it is acceptable for outdoor use.
- Be sure your extension cord is properly wired and in good electrical condition. Always replace a damaged extension cord or have it repaired by a qualified person before using it.
- Protect your extension cords sharp objects, excessive heat and damp or wet areas.

Read and save all instructions for future reference.

Angle-Head Assembly and Assemblies

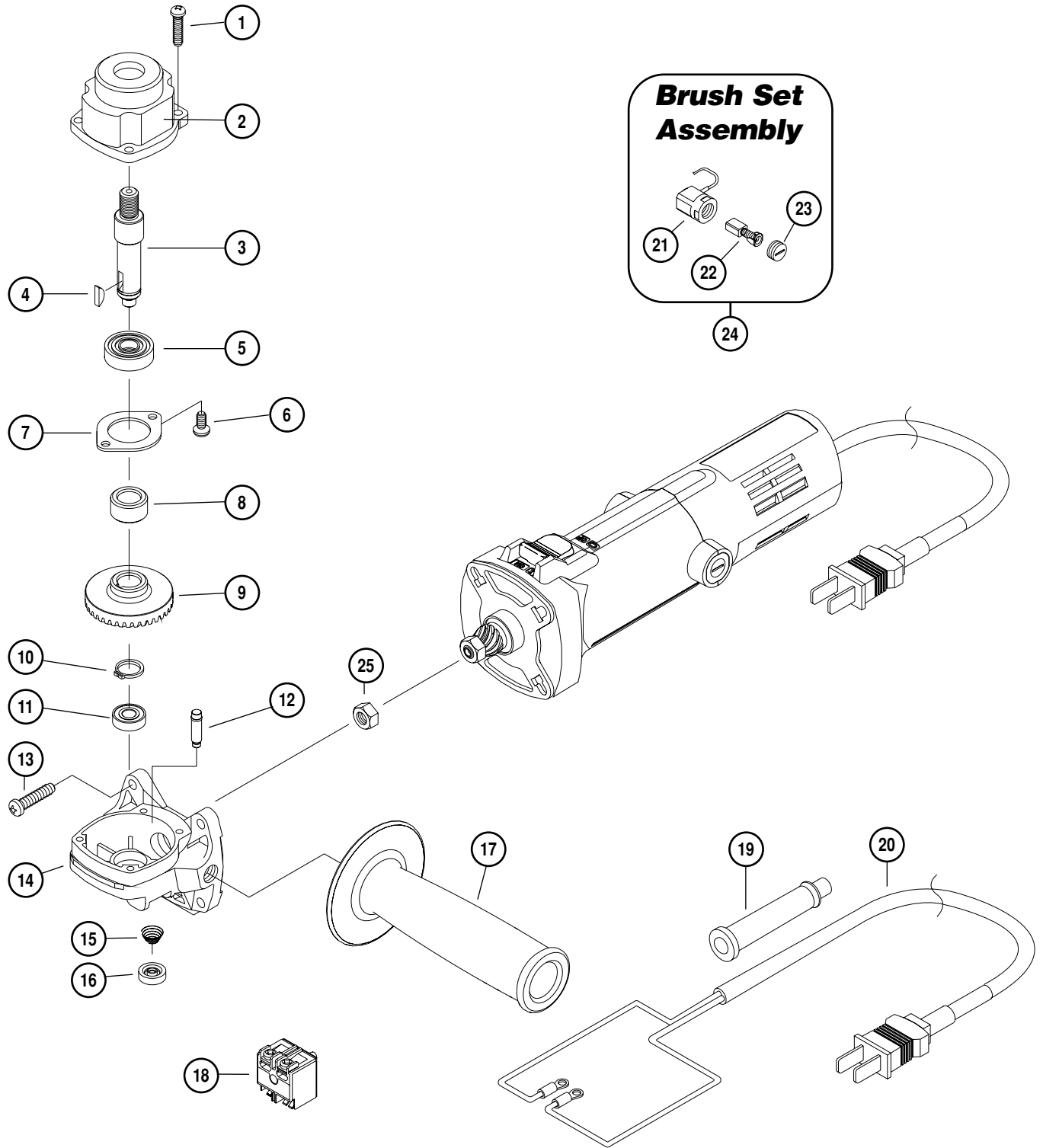

To order replacement parts, specify model number and serial number of your machine.

Index Key

No. Part # Description

1	42710	Screw (4)	10	42719	Retaining Ring	18	42729	Switch
2	42711	Gear Case Cover	11	42720	Upper Spindle Bearing	19	42730	Cord Protector
3	42712	Spindle 3/8"-24	12	42721	Lock Pin	20	42731	Cord Set
4	42713	Key	13	42722	Screw (4)	21	42732	Brush Holder (2)
5	42714	Lower Spindle Bearing	14	42723	Gear Case Assembly (Includes: #12, #15 & #16)	22	42733	Brush (2)
6	42715	Screw (2)	15	42724	Lock Spring	23	42734	Brush Cap (2)
7	42716	Bearing Retainer	16	42725	Lock Button	24	42735	Brush Set Assembly
8	42717	Gear Spacer	17	42726	Side Handle	25	42746	Nut
9	42718	Gear/Pinion Set						

Electric Dynafile® II Contact Arms Arms for 4" to 17" workable reach.

* Note: For belt widths greater than 1/2" use drive wheel 15336 to eliminate slippage.

11200

Work on broad areas, leaves in-line scratch, blend stainless.

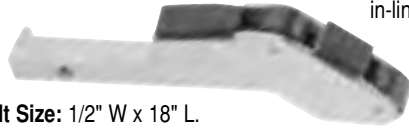

Belt Size: 1/2" W x 18" L.
Contact Wheel: 5/16" dia. x 3/8" W, rubber.
Platen: 1/2" wide.

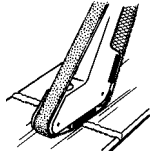

11201

45 PSI maximum. Enter channels as small as 7/16".



Belt Size: 1/2" W x 18" L.
Contact Wheel: 5/16" dia. x 3/8" W, steel.
Platen: 1/2" wide.

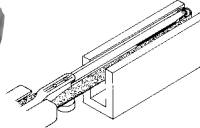

11202

Enter 5/16" x 3/4" openings.



Belt Size: 1/4" W x 18" L.
Contact Wheel: 5/8" dia. x 1/8" W, rubber.
Platen: 1/4" wide.

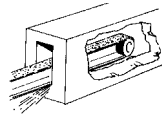

11203* Order 11312 for heavy-duty version.

Grind over contact wheel or platen.



Belt Size: 1/2" W x 18" L.
Contact Wheel: 5/8" dia. x 3/8" W, rubber. **Platen:** 1/2" wide.

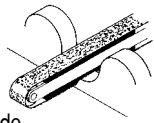

11204 – "Unique Offset Design"

Strap polish is easy with this arm!



Belt Size: 1/4" or 1/2" W x 18" L.
Contact Wheel: 1" dia. x 3/8" W, rubber. **Platen:** None due to offset design.

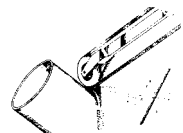

11206* Order 11326 for Heavy Duty/Steel Construction version.



Belt Size: 5/8" or 3/4" W x 18" L.
Contact Wheel: 3/4" dia. x 5/8" wide, rubber. **Platen:** 3/4" wide.

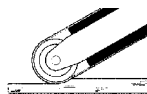

11280

Strap polish here tapered Grind corners, enter grooves, strap polish.



Belt Size: 1/4" W x 18" L.
Contact Wheel: 1" dia. x 3/8" wide, urethane, tapered.
Platen: No platen due to offset design.

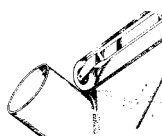

*Standard Contact Arm for Electric Dynafile® II



Optional **40078 Adapter** allows use of 24" long belts; extends reach to 7" when used with contact arm.

11286

11024 steel platen available. 6-3/4" workable reach.



Belt Size: 1/2" W x 24" L.
Contact Wheel: 5/8" dia. x 3/8" W, rubber. **Platen:** 1/2" wide.

11287* Uses 20-1/2" Belts

Grind on contact wheel or platen; has 5-1/4" workable reach.

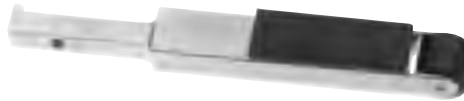

Belt Size: 5/8" or 3/4" W x 20-1/2" L
Contact Wheel: 3/4" dia. x 5/8" W, rubber. **Platen:** 3/4" wide.

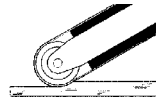

11304 "The Banana Arm"

Work on broad areas; leaves in-line scratch; blend stainless.

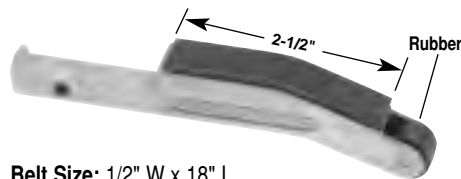

Belt Size: 1/2" W x 18" L.
Contact Wheel: 5/8" dia. x 3/8" wide, rubber. **Platen:** 1/2" wide.

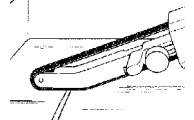

11322 Guide-Cut

Removes raised material within .020" or less without undercutting.

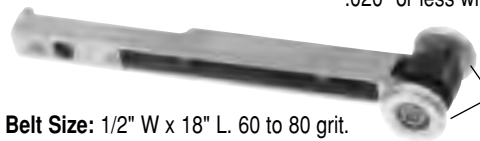

Belt Size: 1/2" W x 18" L. 60 to 80 grit.
Contact Wheel: 5/8" dia. x 3/8" W, rubber.

Guide Wheels Prevent Undercutting

11329 Extra Length Arm

17" workable reach.



Belt Size: 1/2" W x 44" L.
Contact Wheel: 5/8" dia. x 3/8" W, rubber. **Platen:** 1/2" wide.

11350* "Bus Bar"

Excellent for cleaning oxide off electrical bus bars. Arm has a 12" workable reach.



Belt Size: 3/4" W x 34" L.
Contact Wheel: 5/16" dia. x 5/8" W, steel. **Platen:** 3/4" wide, optional.

11220*, 11300*, 11301*, 11341*
Polish Turbine Blades

Offset design and miniature contact wheels. 2" strap polish in offset area; polish turbine blades and other contours.



Belt Sizes: 11220 uses 5/8" or 3/4" W x 18" L. All others use 1/2" W x 18" L.

Contact wheels description for each above arm:

11220: 5/16" dia. x 5/8" W, steel. **11300:** 1/4" dia. x 3/8" W, steel.

11301: 5/16" dia. x 3/8" W, steel. **11341:** 5/16" dia. x 3/8" W, rubber.

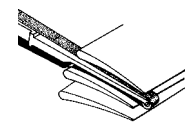

Electric Dynafile® II Contact Arm Assembly Parts List

Contact Wheel Assembly – Includes wheel, bearings and shaft.

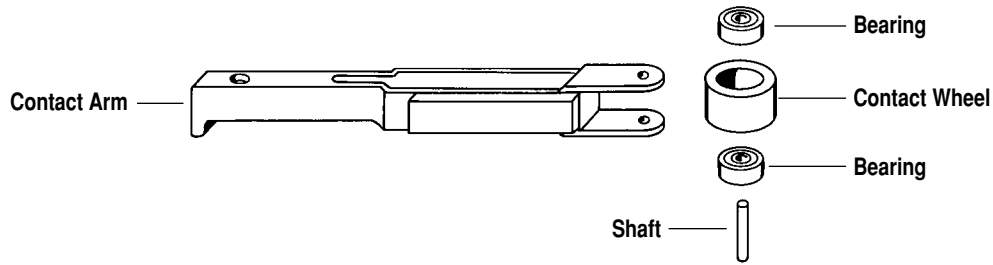

Electric Dynafile® II Standard Contact Arms

Part Number	Abrasive Belt Size	Contact Wheel Description	Comments	Contact Wheel Assembly	Contact Wheel Only	Bearing (2) Req.	Shaft
11200	1/2" x 18"	5/8" Dia. x 3/8" W Rubber	"Stroke-Sander Arm" 1/2" W Platen	11088 (2)	11077 (2)	11052 (4)	11055 (2)
11201	1/2" x 18"	5/16" Dia. x 3/8" W Steel	1/2" W Platen	11068	11067	11051	11054
11202	1/4" x 18"	5/8" Dia. x 1/8" W Rubber	1/4" W Platen	11074	11073	11052	11053
11203	1/2" x 18"	5/8" Dia. x 3/8" W Rubber	1/2" W Platen	11078	11077	11052	11054
11204	1/4" or 1/2" x 18"	1" Dia. x 3/8" Wide Radiused Rubber	Loose Belt Application	11080	11079	11052	11054
11206	5/8" or 3/4" x 18"	3/4" Dia. x 5/8" W Rubber	3/4" W Platen	11282	11281	11052	11285
11220	5/8" or 3/4" x 18"	5/16" Dia. x 5/8" W Steel	Polish Turbine Blades	11352	11353	11051	11285
11280	1/4" x 18"	1" Dia. x 3/8" Wide Tapered Urethane	No Platen/Offset Design	11086	11085	11052	11054
11286	1/2" x 24"	5/8" Dia. x 3/8" W Rubber	1/2" W Platen	11078	11077	11052	11054
11287	5/8" or 3/4" x 20-1/2"	3/4" Dia. x 5/8" W Rubber	3/4" W Platen	11282	11281	11052	11285
11300	1/2" x 18"	1/4" Dia. x 3/8" W Steel	Polish Turbine Blades	11332	11333	11334	11335
11301	1/2" x 18"	5/16" Dia. x 3/8" W Steel	Polish Turbine Blades	11068	11067	11051	11054
11304	1/2" x 18"	5/8" Dia. x 3/8" W Rubber	"Stroke-Sander Arm"-1/2" W Platen	11078	11077	11052	11054
11312	1/2" x 18"	5/8" Dia. x 3/8" W Rubber	H.D. Version of 11203 Arm	11078	11077	11052	11054
11320	1/2" x 18"	5/8" Dia. x 3/8" W Rubber	"Offset Arm" – prevent gouging.	11078	11077	11052	11054
11322	1/2" x 18"	5/8" Dia. x 3/8" W Rubber	Contains two 11395 Guide Wheels – Prevents Undercutting	11090	11077	11052	95610
11325	1/2" x 18"	5/8" Dia. x 3/8" W Rubber	1/2" W Steel Platen	11078	11077	11052	11054
11326	5/8" or 3/4" x 18"	3/4" Dia. x 5/8" W Rubber	H.D. Version of 11206 Arm	11282	11281	11052	11285
11329	1/2" x 44"	5/8" Dia. x 3/8" W Rubber	1/2" W Platen/17" Reach	11078	11077	11052	11054
11341	1/2" x 18"	5/16" Dia. x 3/8" W Rubber	Polish Turbine Blades	11342	11343	11334	11335
11350	3/4" x 34"	5/16" Dia. x 5/8" W Steel	Bus Bar Arm/12" Reach	11352	11353	11051	11285

Contact Arm Assembly/Disassembly Instructions

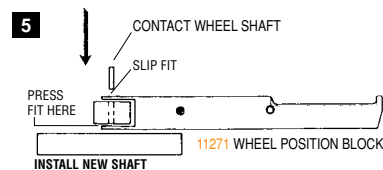
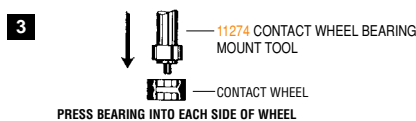
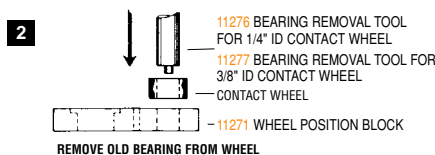
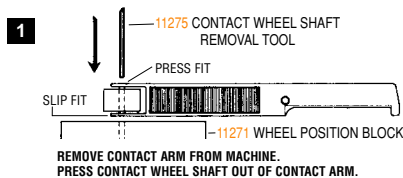

Optional Accessories



11288 Dynaflex Contact Arm and Idler Wheel Repair Kit

- Contains special tools to assist in the replacement of contact wheels and bearings.

Dynapad® Platen Pads

Part Number	Size	Material	Pkg. Qty.
11024	1/2" W x 3" L (bolts on)	Steel	1
11025	1/2" W x 7" L x 1/8" Thk	Soft/Sponge	5
11026	1/2" W x 7" L x 1/8" Thk	Hard/ Cork	5
11027	1/2" W x 7" L x 1/32" Thk	Thin	5
11109	3/4" W x 7" L x 1/8" Thk	Hard/ Cork	5
11119	3/4" W x 7" L x 1/8" Thk	Soft/ Sponge	5
11129	3/4" W x 7" L x 1/32" Thk	Thin	5

Note: Dynapad Platen Pads are PSA mounted and easily trimmed to size.

Exceptions: 11024 and 11028 Steel Platens bolt on; 14341 clamps on.

Unit = 10 packages each.

Machine Specifications

Model Number	Motor RPM	Motor Hp	Abrasive Belt Size Inch (mm)	Voltage	Current	Phase	Frequency	Max. SFPM (SMPM)	Weight Pound (kg)	Length Inch (mm)	Height Inch (mm)
40500	12,000	1	1/4-3/4 (6-19) W x 18-24 (457-610) L	120 V (AC)	4.6 Amps	1	60 Hz	2,600 (790)	4.8 (2.2)	14.5 (356)	5.0 (127)

Reference Contact Information

1. American National Safety Institute – ANSI

24 West 43rd Street
Fourth Floor
New York, NY 10036
Tel: 1 (212) 642-4900
Fax: 1 (212) 398-0023

2. Government Printing Office – GPO

Superintendent of Documents
Attn. New Orders
P.O. Box 371954
Pittsburgh, PA 15250-7954
Tel: 1 (202) 512-1803

3. European Committee for Standardization

Rue de Stassart 36
B - 1050 Brussels, Belgium



Visit Our Web Site: www.dynabrade.com

Email: Customer.Service@Dynabrade.com

DYNABRADE, INC., 8989 Sheridan Drive • Clarence, NY 14031-1490 • Phone: (716) 631-0100 • Fax: 716-631-2073 • International Fax: 716-631-2524
DYNABRADE EUROPE S.à.r.l., Zone Artisanale • L-5485 Wormeldange—Haut, Luxembourg • Telephone: 352 76 84 94 1 • Fax: 352 76 84 95 1

©DYNABRADE, INC., 2004

PRINTED IN USA