

96604 Tune-Up Kit

**For Use With All:
4 hp, Type 1 Horizontal Grinders**

Air Motor and Machine Parts

Parts included in tune-up kit are identified by part number. Not all parts are required for all models. Please refer to appropriate parts page for additional identification and disassembly/assembly instructions.

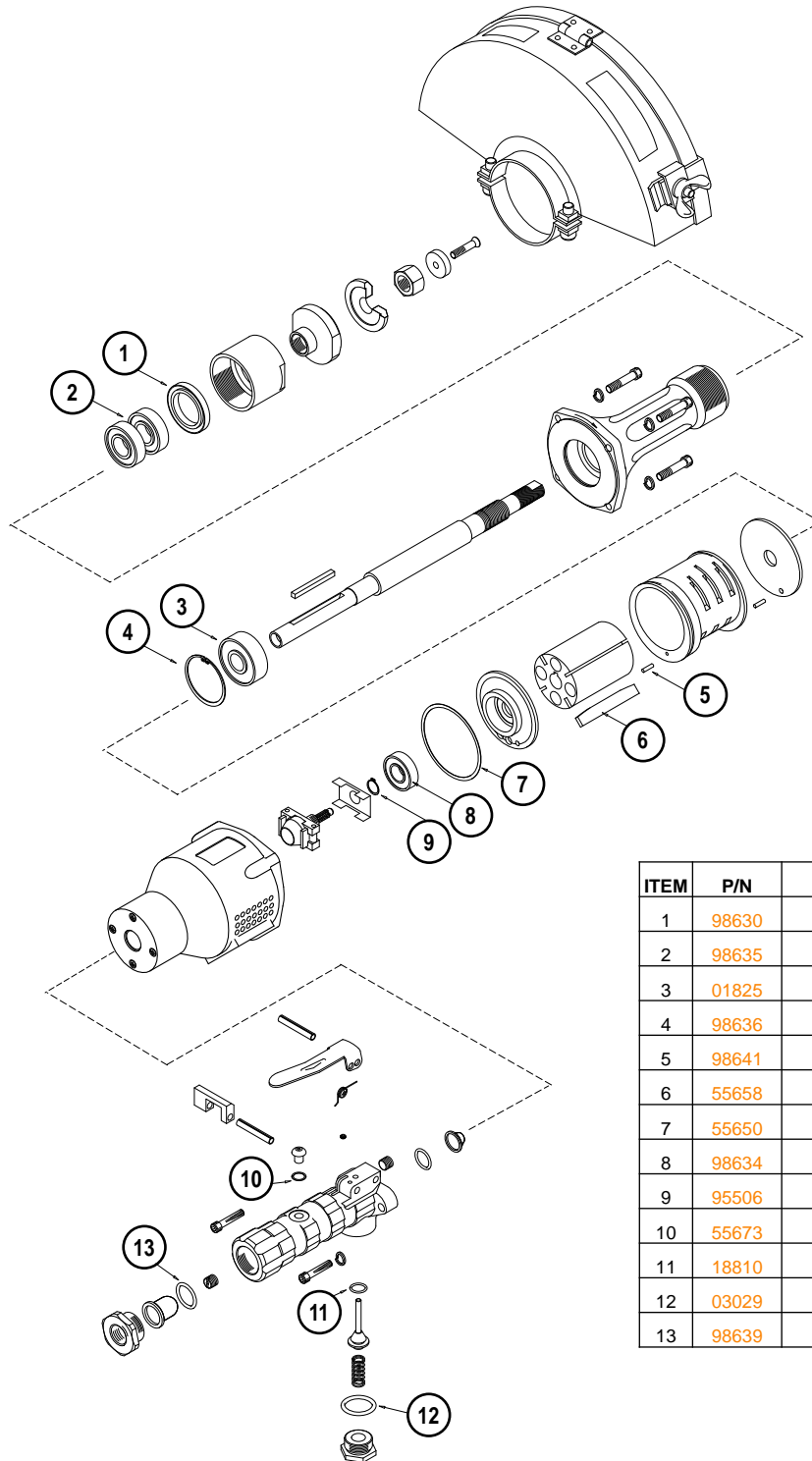

ITEM	P/N	DESCRIPTION	QTY.
1	98630	SEAL	1
2	98635	BEARING	2
3	01825	BEARING	1
4	98636	RETAINING RING	1
5	98641	PIN	2
6	55658	VANE (5/PKG)	1
7	55650	GASKET	1
8	98634	BEARING	1
9	95506	RETAINING RING	1
10	55673	SEAL	1
11	18810	O-RING	1
12	03029	O-RING	1
13	98639	O-RING	1

DYNABRADE, INC.

www.dynabrade.com

8989 Sheridan Drive • Clarence, NY 14031-1490 • Phone: 716-631-0100 • Fax: 716-631-2073 • International Fax: 716-631-2524
©DYNABRADE, INC., 2013 PRINTED IN USA PD13.29_09/13

